



Bringing Value to Life

vinyl playsets



TABLE OF CONTENTS

Index	2
About Us	4
Quality/Craftsmanship	6
Vinyl	8
Testimonial	9
Kids Health	10
FAQ's	12
Warranty	13
Space Shuttle Series	14
Pirate Ship Series	28
Teddy Bear Series	46
Build Your Own Adventure	60
Surfacing Options	70

Catalog Designed by
Creative Solutions Group, LLC

SPACE SHUTTLE

-LARGE SERIES-

14 Rocket Blazer Xtreme

16 The Galaxy

18 The Space Station

20 The Launching Pad

22 The Space Walk

24 The Shooting Star

26 The Eclipse

PIRATE SHIP

-MEDIUM SERIES-

28 The Pirate's Palace

30 The Sea King

32 The Sailor's Retreat

34 The Storm Chaser

36 The Safe Harbor

38 The Captain's Castle

40 The Wave Rider

42 The Captain's Pearl

44 The Starboard Escape

TEDDY BEAR

-SMALL SERIES-

46 The Care Bear Castle

48 Cubby's Fort

50 The Wish Bears Dream

52 The Honeybear Hangout

54 Teddy's Tower

56 The Fuzzy Bear Ride

58 Economy Swingset

ABOUT US **KING SWINGS**

It all started 25 years ago in a 1600-square-foot workshop in Lancaster, PA. **King Swings**, a family owned and operated company, began designing, manufacturing, and installing swing sets. Today our production facility was swelled to 34,000 square feet. Made by some of the finest Amish craftsmen in the country, our swing sets will provide long hours of fun for your children and grandchildren.

We make sure our swing sets are safe. Built to support adult weight, the deck surfaces can bear up to 250 pounds and most rides up to 200 pounds (except plastic gliders). So parents, you can play along with your kids!

Swing sets are unmatched for aiding in children's physical, mental, social and emotional development. Exercising in fresh air stimulates muscle growth, increases coordination, and develops the mind.

Thank you for choosing **King Swing** products.
We're confident you will not be disappointed.

Bernard S. King
-Owner-

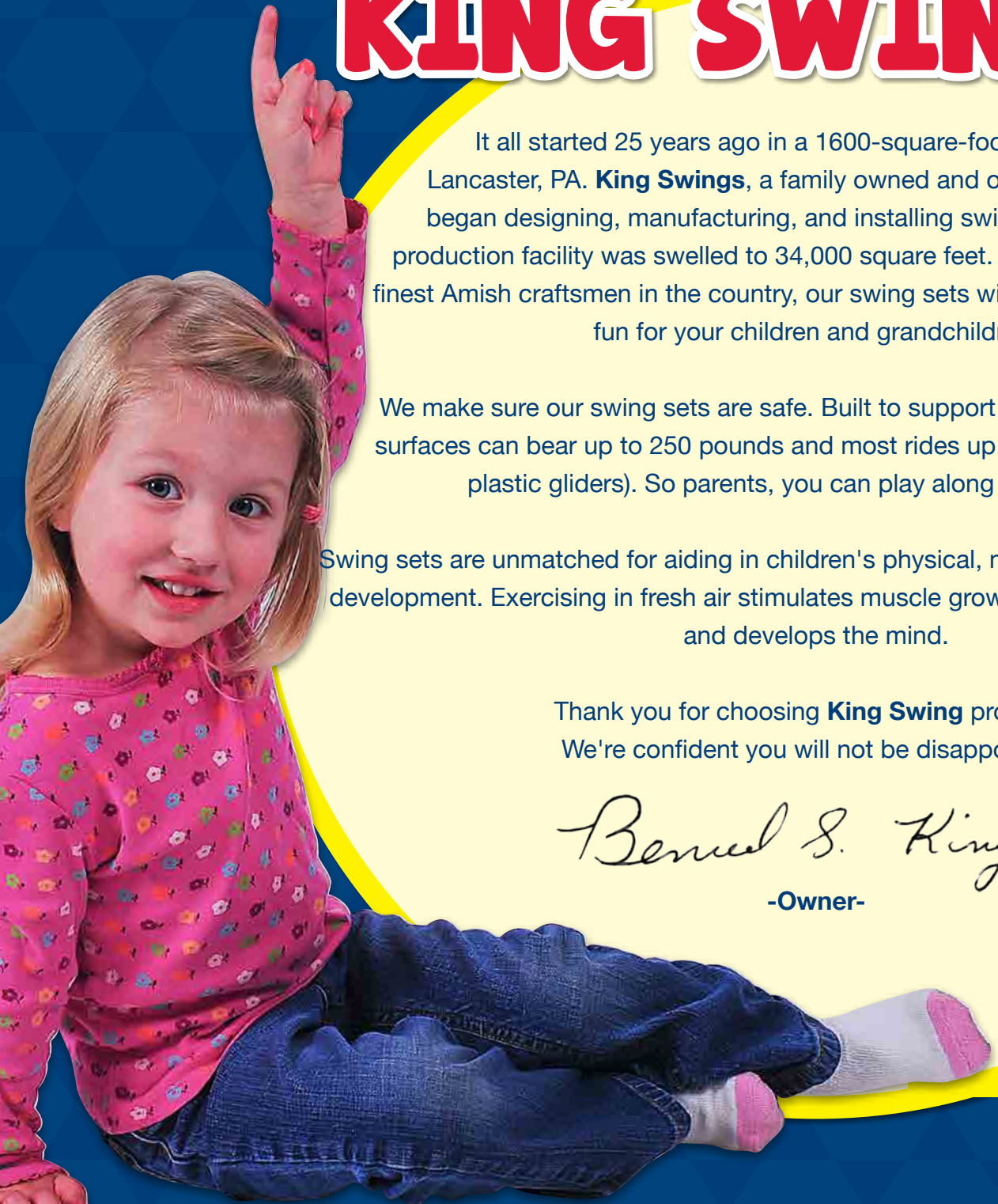

* We offer moving services on all swingsets. Contact your local dealer for info.

QUALITY'S IN THE DETAILS!



Easy Access Points & Safety Hand Rails



Our Swing Bars are Approx. 10' High

Heavy Duty A-Frames



Smooth Non-Fading Vinyl Surface

Durable Heat Resistant Plastic

WHAT GOES INTO OUR SWINGSETS

It all starts with discarded plastic. Yes that's right, the same plastic you throw away after you drink a bottle of water. The compounds in that plastic is used to make the vinyl in our swingsets.



Rest assured, all our materials are environmentally friendly and we only use stainless steel hardware! The end result is one your entire family can enjoy.



We then cut and size lumber to provide strength and stability. We use "lifetime guaranteed preserved wood" and then cover it with a vinyl sleeve and caps to insure a maintenance free and splinter free finish. We use only the finest materials available.



CUSTOMER TESTIMONIAL

"We really appreciated the ability to custom design this swingset for our needs. We only had a small area available for it, and were able to put more action into that area than any other brand could. We would certainly deal with Kingswings again in the future."

The Strasburg Railroad - Strasburg, PA



Lifetime pressure treated lumber is inside vinyl sleeve.

ACTIVE KIDS ^{Are} HEALTHY KIDS

DID YOU KNOW?
50% OF KIDS

do not get enough exercise which increases their risk of becoming obese!

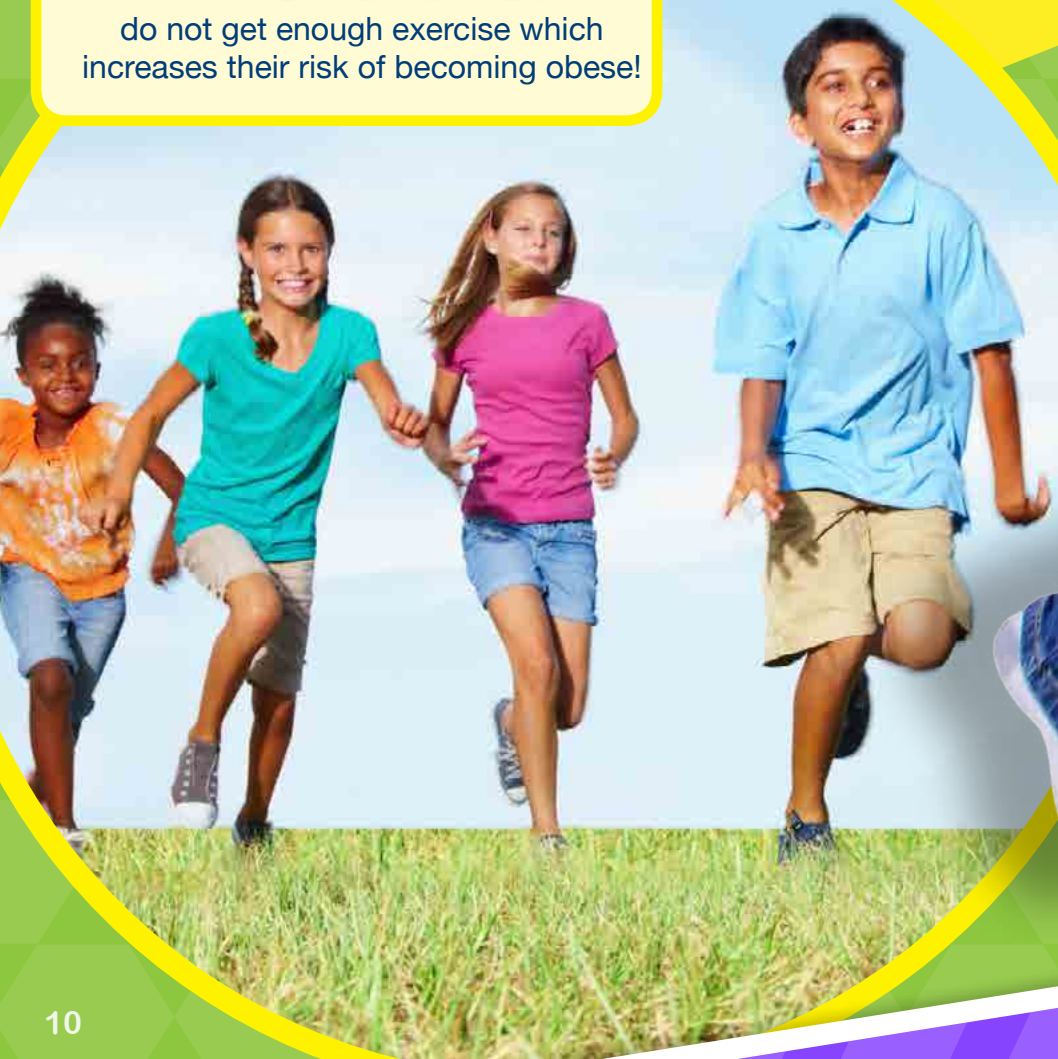

SO GET OUT

& PLAY!

WHY BUY A SWINGSET

- Time outside lowers children's risk of hyperactivity and depression.
- Outside play stimulates kids' imaginations, expanding their creative thinking.
- Children who create and play together face-to-face get along better with others.
- Children who spend time outside are calmer.
- Fresh air and exercise help stave off infections, colds, and the flu.



FREQUENTLY ASKED **QUESTIONS?**

Q: Will vinyl fade, due to sun?

A: No, it has a long lasting UV protection to keep the original color for many years

Q: How do we clean our vinyl playset?

A: Very Easy! Use a soft brisled brush and soap.

Q: Will vinyl chip or get a rough surface?

A: Only if it is damaged with a sharp or heavy object
(Example: A hammer or sharpe knife).

Q: Will the slides get hot in the summer time?

A: No, the plastic material will deflect the sun rays heat from the slides.

Q: Can a grown adult use the swings and gliders?

A: Sure, go out and enjoy some fun with your children! Our play decks have a tip-proof design and will easily support an adult.

LIMITED LIFETIME & **20 & 6 YEAR WARRANTY**

King Swings warrants its swingsets used in residential applications. To receive warranty benefits, the enclosed warranty application must be filled out and mailed to King Swings within 90 days of purchase. Warranties are for original purchaser at the original installation address, Any alterations, relocation, or improper installation of your playset will void the warranty.

King Swings warrants that workmanship of your playset will be without fault for up to 6 years. We extend a limited lifetime warranty on all pressure treated lumber against decay & insect damage. All PVC plastic lumber is backed by our 20 Yr. Warranty against fading & discoloration. In addition all canopies, sliding boards, metal components, swings and accessories are warranted for 6 years from purchase. King Swings products are not warranted as being suitable for a particular purpose. The suitability of the product is for the purchaser to determine. This warranty does not cover normal wear and tear, failure to properly maintain the playset, or damage resulting from misuse or abuse of the product. All damage done by acts of nature such as lightning, storms, hurricanes, tornadoes, earthquakes or any extreme weather conditions are not covered.

King Swings reserves the right to request photographs and/or physical evidence of the product claimed to be defective, and to recover product prior to any warranty work being authorized. All shipments of products returned for inspection will be paid by consumer. If the defect is covered by manufacturers warranty, the manufacturer will remedy the warranty claim within a reasonable time frame. The remedy will consist of repair or replacement of the

defective piece unless it is not practical. If this would be the outcome manufacturer will reimburse the original purchaser for the value of the defective piece.

Adult supervision is recommended while children are enjoying their playset. All children must maintain a safe distance from moving play equipment. For safety and comfort reasons, the manufacturer reserves the right to make design & structural changes without notice.



ROCKET BLAZER XTREME

Play Deck Roofing Choices



Fabric

Plastic

ROCKET BLAZER XTREME

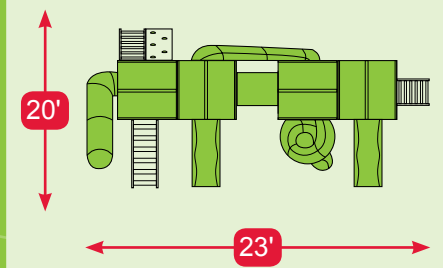

Border Needed:
100'
Rubber Mulch Needed:
3 Ton
Wood Mulch Needed:
12 cu. yds.
Weed Guard Needed:
975 sq. ft.
Total Space Needed:
27' x 30'

This Model Includes:

Towers	(2) 4x8 Double Deck Towers
Tower Connectors	3' Tunnel Tube
Slides	7' Turbo, 10' & 14' Avalanche Slides, 10' Side Winder, 18' Ball Bit Blast
Climbers	5' Ladder, 5' Rock Climbing Wall/Ladder Combo, 12' Ramp
Sandbox	4' x 4' (12 Bags of Sand Needed)
Roof Type	Fabric
Swing Bar	N/A
Rides	Deluxe baby Swing
Fun Accessories	Ship Wheel, Telescope, Tic-Tac-Toe, Ball Pit w/ 1500 Playballs, 4' Picnic Table



Rear View

V-12

THE GALAXY

9' Deck Height

Play Deck Roofing Choices



Fabric



Plastic



THE GALAXY

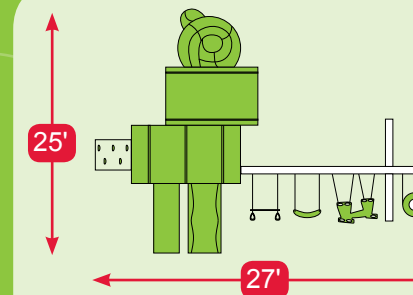

Border Needed:
132'
Rubber Mulch Needed:
3 Ton
Wood Mulch Needed:
11 cu. yds.
Weed Guard Needed:
105 squ. ft.
Total Space Needed:
33' x 33'

This Model Includes:

Towers	Triple Cascade Tower
Tower Connectors	N/A
Slides	14' Avalanche Slide, 9' Super Spiral Slide
Climbers	2' Ramp 5' full width Rock Climbing Wall
Sandbox	4'x8' (24 Bags of Sand Needed)
Roof Type	Plastic
Swing Bar	4 Positions 10' High Beam, Free Standing Double Hammock Swing
Rides	Belt Swing, Trapeze Bar, Plastic Glider, 4 Rope Tire Swing, Hammock Swing, Double Hammock Swing, Deluxe Baby Swing
Fun Accessories	Ship Wheel, Telescope, Tic-Tac-Toe, Tea Table and Chairs, Bubble Panel



THE SPACE STATION

Playhouse Roofing



Asphalt

Did You Know?

Kids who play video games have shorter attention spans than those who exercise.



V-B

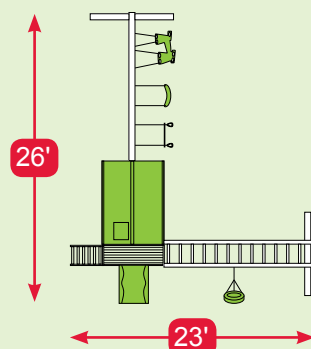

THE SPACE STATION

Border Needed: 112'
Rubber Mulch Needed: 3 Ton
Wood Mulch Needed: 9 cu. yds.
Weed Guard Needed: 925 squ. ft.
Total Space Needed: 29' x 32'

This Model Includes:

Towers	6' x 6' Playhouse w/ 2' Deck
Tower Connectors	N/A
Slides	10' Waterfall Slide
Climbers	Staircase
Sandbox	6' x 6' (27 Bags of Sand Needed)

Roof Type	Asphalt
Swing Bar	3 Position Monkey Bar, 3 Position 10' High Beam
Rides	Belt Swing, Trapeze, Plastic Glider, Tire Swing
Fun Accessories	Ship Wheel, Telescope

THE LAUNCHING PAD

Play Deck Roofing Choices



Fabric



Plastic



THE LAUNCHING PAD

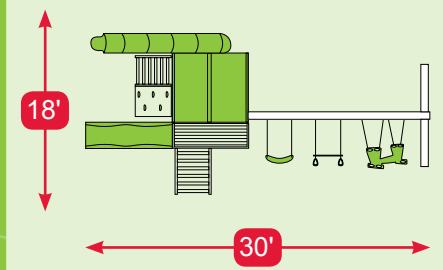

- Border Needed:** 98'
- Rubber Mulch Needed:** 2 Ton
- Wood Mulch Needed:** 6 cu. yds.
- Weed Guard Needed:** 800 sq. ft.
- Total Space Needed:** 24' x 36'

This Model Includes:

Towers	6' x 8' Double Deck Playhouse Tower
Tower Connectors	N/A
Slides	10' Avalanche Slide, 14' Sidewinder Slide
Climbers	Staircase, 7' Rock Climbing Wall Ladder Combo
Sandbox	4' x 6' (18 Bags of Sand Needed)
Roof Type	Plastic
Swing Bar	3 Position 10' High Beam
Rides	Belt Swing, Trapeze, Plastic Glider
Fun Accessories	1 Ship Wheel, 1 Telescope, Tic-Tac-Toe



Rear View

V-M

THE SPACE WALK

Play Deck Roofing Choices



Fabric



Plastic



Did You Know?

Kids do better on tests when they play first because of increased brain oxygen.

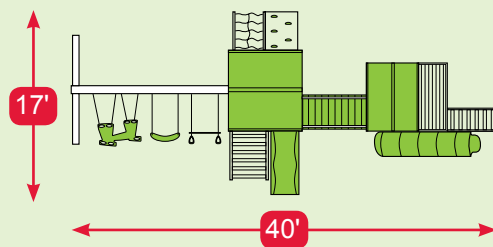

THE SPACE WALK

- Border Needed:** 124'
- Rubber Mulch Needed:** 3 Ton
- Wood Mulch Needed:** 9 cu. yds.
- Weed Guard Needed:** 945 sq. ft.
- Total Space Needed:** 23' x 46'

This Model Includes:

Towers	Mountain Climber, 4' x 4' Playdeck
Tower Connectors	Wobbly Bridge
Slides	10' Avalanche Slide, 10' Sidewinder
Climbers	5' Rock Climbing Wall, Cargo Net, 5' Ladder, 12' Ramp
Sandbox	4' x 4' (12 bags of Sand Needed)

Roof Type	Fabric
Swing Bar	3 Position 10' High Beam
Rides	Trapeze, Plastic Glider, Belt Swing, Tire Swing
Fun Accessories	2 Telescope, 2 Ship Wheel, 1 Tic-Tac-Toe

THE SHOOTING STAR

Play Deck Roofing Choices



Fabric

Plastic

THE SHOOTING STAR

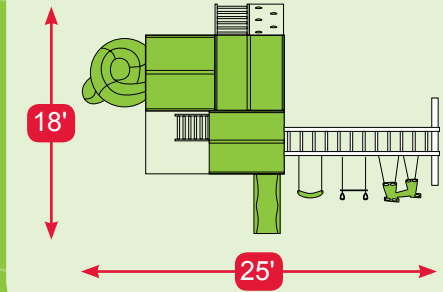

- Border Needed:** 110'
- Rubber Mulch Needed:** 2 Ton
- Wood Mulch Needed:** 6 cu. yds.
- Weed Guard Needed:** 770 sq. ft.
- Total Space Needed:** 24' x 32'

This Model Includes:

Towers	8' x 8' Triple Deck Tower
Tower Connectors	N/A
Slides	7 Super Spiral Slide, 8' Waterfall Slide
Climbers	3' Ladder, 4' Ladder, 5' Rock Climbing Wall/ Ladder Combo
Sandbox	4' x 4' (12 Bags of Sand Needed)
Roof Type	Fabric
Swing Bar	3 Position Monkey Bar
Rides	Belt Swing, Trapeze, Plastic Glider
Fun Accessories	4' Picnic Table, Tic-Tac-Toe, 2 Telescopes, 1 Periscope, 2 Ship Wheels, Steering Wheel, Bubble Panel, Ball Pit w/ 1500 Playpen Balls

Did You Know?

Tests prove that children who are physically fit have larger 'basal ganglia', a key part of the brain that helps maintain attention span and the ability to coordinate thoughts and actions.

V-14

THE ECLIPSE

Play Deck Roofing Choices



Fabric

Plastic

THE ECLIPSE

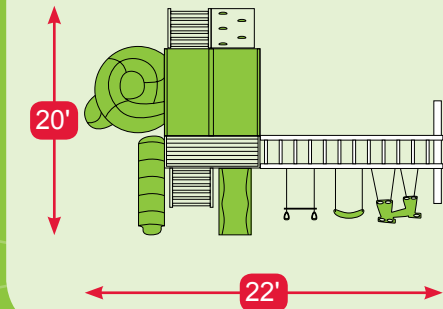

Border Needed:
98'
Rubber Mulch Needed:
2 Ton
Wood Mulch Needed:
6 cu. yds.
Weed Guard Needed:
800 sq. ft.
Total Space Needed:
26' x 28'

This Model Includes:

Towers	6' x 8' Double Deck
Tower Connectors	N/A
Slides	7' Turbo Tube Slide, 10' Side Winder Slide, 10' Avalanche Slide
Climbers	7' Rock Climbing Wall/Ladder Combo, Staircase
Sandbox	4' x 6' (18 Bags of Sand Needed)
Roof Type	Plastic
Swing Bar	3 Position Monkey Bar
Rides	Belt Swing, Trapeze, Plastic Glider
Fun Accessories	Bubble Panel, Tic-Tac-Toe, Ship Wheel, Telescope



V-LD

THE PIRATE'S PALACE

THE PIRATE'S PALACE

Playhouse Roofing



Asphalt

Border Needed:

98'

Rubber Mulch Needed:

2 Ton

Wood Mulch Needed:

6 cu. yds.

Weed Guard Needed:

545 squ. ft.

Total Space Needed:

23' x 29'

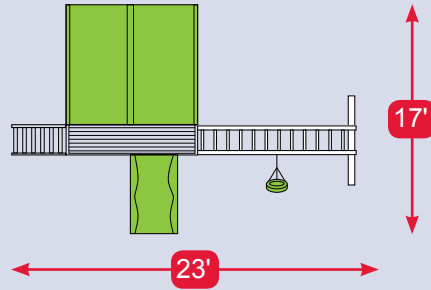

This Model Includes:

Towers	6' x 6' Playhouse with 2' Front Deck
Tower Connectors	N/A
Slides	10' Waterfall Slide
Climbers	Staircase
Sandbox	6' x 6' (27 Bags of Sand Needed)
Roof Type	Asphalt
Swing Bar	3 Position Monkey Bar
Rides	Tire Swing
Fun Accessories	Ship Wheel, Telescope



V-I

THE SEA KING

THE SEA KING

Play Deck Roofing Choices



Fabric

Plastic

Border Needed:

98'

Rubber Mulch Needed:

2 Ton

Wood Mulch Needed:

6 cu. yds.

Weed Guard Needed:

545 squ. ft.

Total Space Needed:

17' x 31'

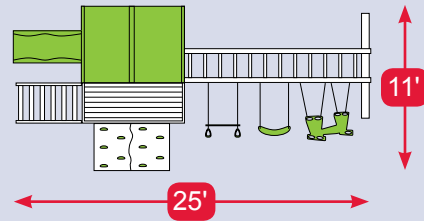

This Model Includes:

Towers	6' x 8' Play Deck
Tower Connectors	N/A
Slides	10' Waterfall Slide
Climbers	Full Width Rock Climbing Wall, Staircase
Sandbox	6' x 6' (27 Bags of Sand Needed)
Roof Type	Plastic
Swing Bar	3 Position Monkey Bar
Rides	Belt Swing, Trapeze, Plastic Glider
Fun Accessories	Telescope, Ship Wheel, Tic-Tac-Toe



Over-sized family play deck!

THE SAILOR'S RETREAT

Playhouse Roofing



Asphalt

THE SAILOR'S RETREAT

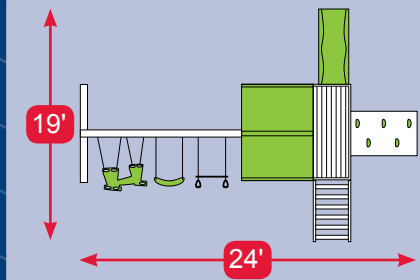

Border Needed:
96'
Rubber Mulch Needed:
2 Ton
Wood Mulch Needed:
7 cu. yds.
Weed Guard Needed:
575 squ. ft.
Total Space Needed:
25' x 32'

This Model Includes:

Towers	6' x 6' Playhouse with 2' Front Deck
Tower Connectors	N/A
Slides	10' Waterfall Slide
Climbers	Staircase, Full Width Climbing Wall
Sandbox	6' x 6' (27 Bags of Sand Needed)
Roof Type	Asphalt
Swing Bar	3 Position 10' High Beam
Rides	Belt Swing, Plastic Glider, Trapeze
Fun Accessories	Ship Wheel, Telescope

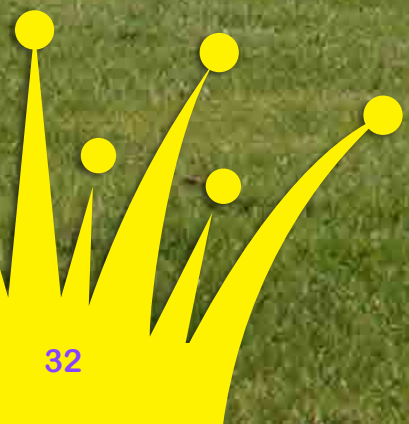

V-C

THE STORM CHASER

Border Needed:
88'
Rubber Mulch Needed:
2 Ton
Wood Mulch Needed:
6 yrds.
Weed Guard Needed:
552 squ. ft.
Total Space Needed:
24' x 23'

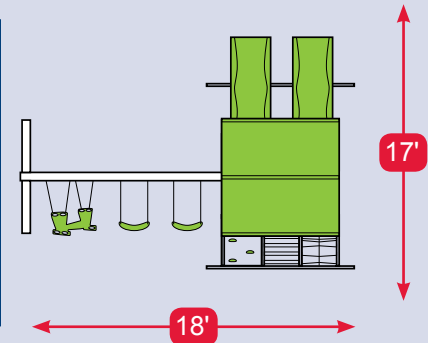

This Model Includes:

Towers	5' X 6' Climber Tower
Tower Connectors	N/A
Slides	(2) 10' Waterfall Slide
Climbers	Rock Climbing Wall, Cargo Net, Ladder
Sandbox	N/A
Roof Type	Fabric
Swing Bar	3 Position 8' High Beam
Rides	Trapeze, Plastic Glider, Belt Swing
Fun Accessories	Tic-Tac-Toe, Telescope, Ship Wheel



Play Deck Roofing Choices



Fabric

THE STORM CHASER



THE SAFE HARBOR

Play Deck Roofing Choices



Fabric

Plastic

THE SAFE HARBOR

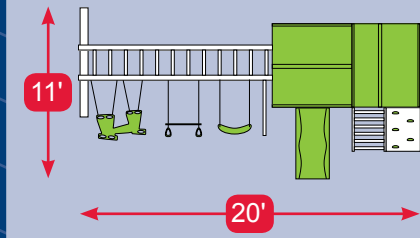

Border Needed:
86'
Rubber Mulch Needed:
2 Ton
Wood Mulch Needed:
5 yds.
Weed Guard Needed:
440 sq. ft.
Total Space Needed:
17' x 26'

This Model Includes:

Towers	4' x 8' Split Level Playdeck
Tower Connectors	N/A
Slides	10' Waterfall Slide
Climbers	4' Rock Climbing Wall/Ladder Combo
Sandbox	4' x 8' (24 Bags of Sand Needed)
Roof Type	Fabric
Swing Bar	3 Position Monkey Bar
Rides	Trapeze, Belt Swing, Plastic Glider
Fun Accessories	Ship Wheel, Telescope, Tic-Tac-Toe



V-P

THE CAPTAIN'S CASTLE

THE CAPTIAN'S CASTLE



Border Needed:
96'
Rubber Mulch Needed:
2 Ton
Wood Mulch Needed:
6 yrds.
Weed Guard Needed:
605 squ. ft.
Total Space Needed:
20' x 30'

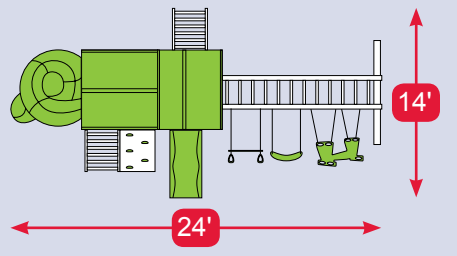

This Model Includes:

Towers	4' x 8' Double Deck
Tower Connectors	N/A
Slides	10' Waterfall Slide, 7' Super Spiral Slide
Climbers	5' Ladder, 7' Rock Climbing Wall/Ladder Combo
Sandbox	4' x 8' (24 Bags of Sand Needed)
Roof Type	Plastic
Swing Bar	3 Position Monkey Bar
Rides	Trapeze, Belt Swing, Plastic Glider, Deluxe Baby Swing
Fun Accessories	Ship Wheel, Telescope, Tic-Tac-Toe



THE WAVE RIDER

Play Deck Roofing Choices



Fabric

Plastic

THE WAVE RIDER

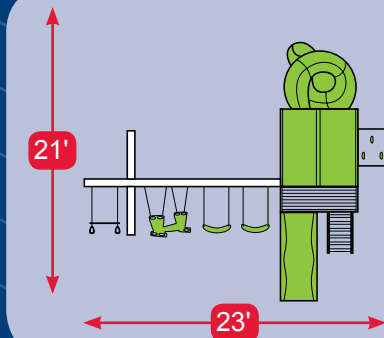

Border Needed:
110'
Rubber Mulch Needed:
2 Ton
Wood Mulch Needed:
9 yds.
Weed Guard Needed:
864 sq. ft.
Total Space Needed:
27' x 32'

This Model Includes:

Towers	6' x 8' Play Deck
Tower Connectors	N/A
Slides	10' Waterfall Slide, 7' Turbo Tube Slide
Climbers	5' Ladder, 5' Full Width Rock Climbing Wall
Sandbox	6' x 6' (26 Bags of Sand Needed)
Roof Type	Fabric
Swing Bar	4 Position 8' High Beam
Rides	2 Belt Swings, Trapeze Bar, Plastic Glider
Fun Accessories	Telescope, Ship Wheel



V-S

Over-sized family play deck!

THE CAPTAIN'S PEARL

Play Deck Roofing Choices



Fabric

Plastic

THE CAPTAIN'S PEARL

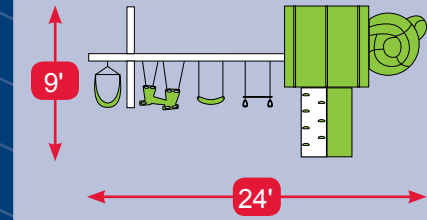

- Border Needed:** 96 ft.
- Rubber Mulch Needed:** 2 Ton
- Wood Mulch Needed:** 5 yds.
- Weed Guard Needed:** 450 sq. ft.
- Total Space Needed:** 15' x 30'

This Model Includes:

Towers	6x6 Play deck
Tower Connectors	N/A
Slides	5' Super Spiral Slide
Climbers	5' Climbing Wall/Ladder Combo
Sandbox	6x6 (24 bags of sand needed)
Roof Type	Plastic
Swing Bar	4 positions, 8' high beam
Rides	Belt Swing, Trapeze Bar, Plastic Glider, Hammock Swing
Fun Accessories	Ship Wheel, Telescope, Tea Table and Chairs



THE STARBOARD ESCAPE

THE STARBOARD ESCAPE

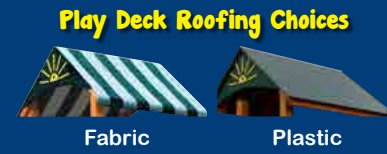

Border Needed:
86'
Rubber Mulch Needed:
2 Ton
Wood Mulch Needed:
6 yrds.
Weed Guard Needed:
595 squ. ft.
Total Space Needed:
23' x 26'

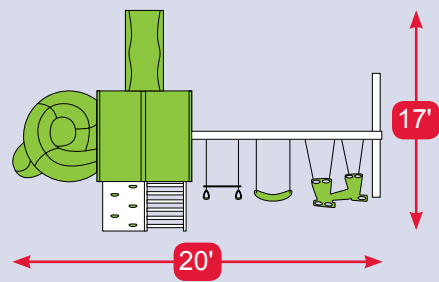

This Model Includes:

Towers	4' x 6' Playdeck
Tower Connectors	N/A
Slides	10' Waterfall Slide, 5' Super Spiral Slide
Climbers	5' Rock Climbing Wall/Ladder Combo
Sandbox	4' x 6' (18 Bags of Sand Needed)
Roof Type	Fabric
Swing Bar	3 Position 8' High Beam
Rides	Plastic Glider, Belt Swing, Trapeze
Fun Accessories	Tic-Tac-Toe, Telescope, Ship Wheel



V-Q-10

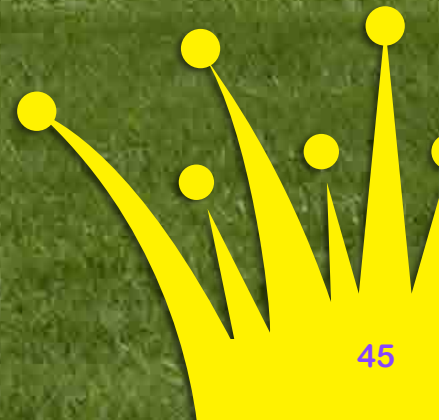

THE CARE BEAR CASTLE

Play Deck Roofing Choices



Fabric

Plastic

THE CARE BEAR CASTLE

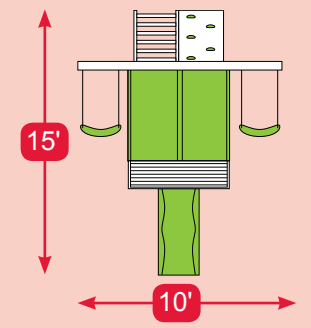

- Border Needed:** 64'
- Rubber Mulch Needed:** 1 Ton
- Wood Mulch Needed:** 3 cu. yds.
- Weed Guard Needed:** 240 sq. ft.
- Total Space Needed:** 12' x 20'

This Model Includes:

Towers	4' x 4' Playdeck
Tower Connectors	N/A
Slides	10' Waterfall Slide
Climbers	5' Rock Climbing Wall/Ladder Combo
Sandbox	4' x 4' (12 Bags of Sand Needed)
Roof Type	Fabric
Swing Bar	2 Position 8' High Beam
Rides	2 Belt Swing
Fun Accessories	Telescope, Ship Wheel, Tic-Tac-Toe

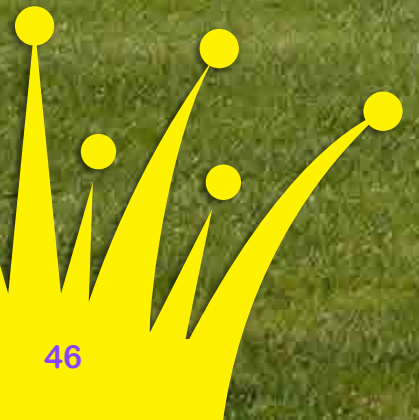

V-E

CUBBYS FORT

CUBBYS FORT

Border Needed:

80'

Rubber Mulch Needed:

1 Ton

Wood Mulch Needed:

4 yrds.

Weed Guard Needed:

335 sq. ft.

Total Space Needed:

12' x 29'

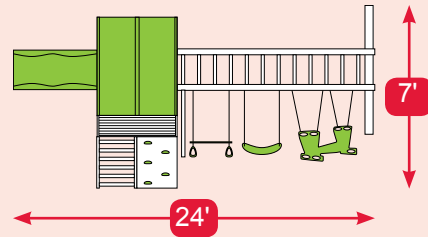

This Model Includes:

Towers	4' x 4' Playdeck
Tower Connectors	N/A
Slides	10' Waterfall Slide
Climbers	5' Rock Climbing Wall/Ladder Combo
Sandbox	4' x 4' (12 Bags of Sand Needed)
Roof Type	Plastic
Swing Bar	3 Position Monkey Bar
Rides	Belt Swing, Trapeze, Plastic Glider
Fun Accessories	Telescope, Ship Wheel, Tic-Tac-Toe



V-R

THE WISH BEAR DREAM



V-G

THE WISH BEARS DREAM

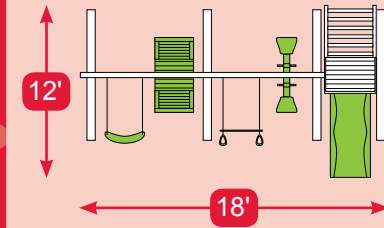

- Border Needed:**
70'
- Rubber Mulch Needed:**
1 Ton
- Wood Mulch Needed:**
3 cu. yds.
- Weed Guard Needed:**
300 sq. ft.
- Total Space Needed:**
16' x 20'

This Model Includes:

Towers	N/A
Tower Connectors	N/A
Slides	10' Waterfall Slide
Climbers	N/A
Sandbox	N/A
Roof Type	N/A
Swing Bar	5 Position 8' High Beam
Rides	1 Belts, Trapeze, Basket Glider, Teetor Totter
Fun Accessories	N/A



THE HONEYBEAR HANGOUT

THE HONEYBEAR HANGOUT

- Border Needed:**
68'
- Rubber Mulch Needed:**
1 Ton
- Wood Mulch Needed:**
3 cu. yds.
- Weed Guard Needed:**
288 squ. ft.
- Total Space Needed:**
16' x 18'

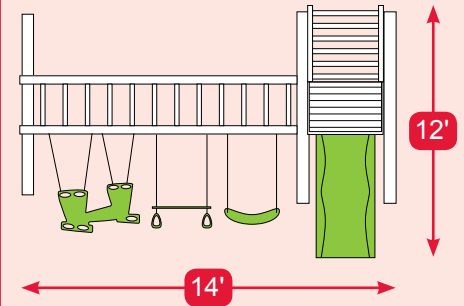

This Model Includes:

Towers	N/A
Tower Connectors	N/A
Slides	10' Waterfall Slide
Climbers	N/A
Sandbox	N/A
Roof Type	N/A
Swing Bar	3 Position Monkey Bar
Rides	Belt Swing, Trapeze, Plastic Glider
Fun Accessories	N/A



V-MB

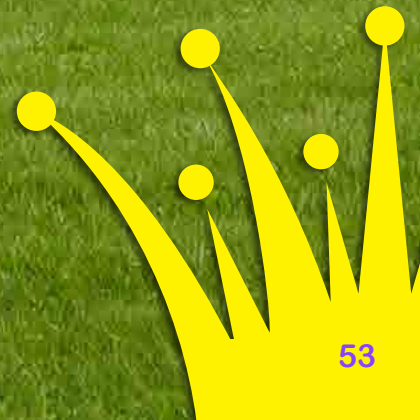

TEDDY'S TOWER

Play Deck Roofing Choices



Plastic



Fabric



V-H10

TEDDYS TOWER

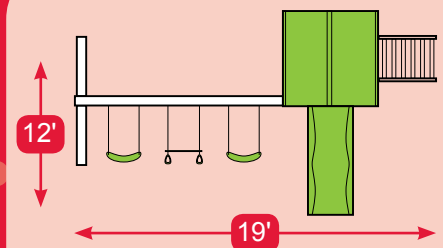

- Border Needed:**
80'
- Rubber Mulch Needed:**
1 Ton
- Wood Mulch Needed:**
5 cu. yds.
- Weed Guard Needed:**
480 sq. ft.
- Total Space Needed:**
18' x 25'

This Model Includes:

Towers	4' x 4' Playdeck
Tower Connectors	N/A
Slides	10' Waterfall Slide
Climbers	5' Ladder
Sandbox	4' x 4' (12 bags of sand needed)
Roof Type	Fabric
Swing Bar	3 Position 8' High Beam
Rides	2 Belt Swing, Trapeze Bar
Fun Accessories	Telescope, Ship's Wheel



THE FUZZY BEAR RIDE



V-H

THE FUZZY BEAR RIDE

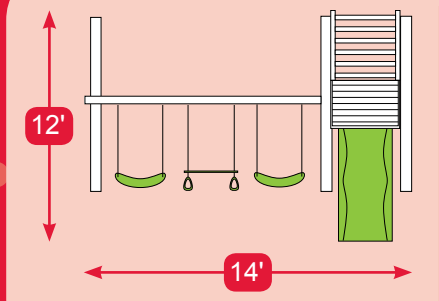

- Border Needed:** 64'
- Rubber Mulch Needed:** 1 Ton
- Wood Mulch Needed:** 3 yds.
- Weed Guard Needed:** 250 sq. ft.
- Total Space Needed:** 16' x 16'

This Model Includes:

Towers	N/A
Tower Connectors	N/A
Slides	10' Waterfall Slide
Climbers	N/A
Sandbox	N/A
Roof Type	N/A
Swing Bar	3 Position 8" High Beam
Rides	2 Belt Swings, Trapeze
Fun Accessories	N/A



ECONOMY SWINGSET



V-F10

This Model Includes:

Towers	N/A
Tower Connectors	N/A
Slides	N/A
Climbers	N/A
Sandbox	N/A
Roof Type	N/A
Swing Bar	3 Position 10' High Beam
Rides	2 Belts, PLastic Glider
Fun Accessories	N/A

Did You Know?

Our swingsets are built for big kids too! Some rides can even hold up to 250 lbs. So get out there and have a blast with your kids.

ECONOMY SWINGSET

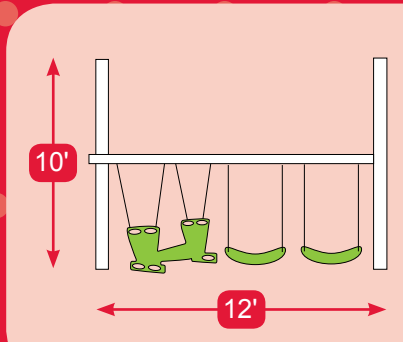

- Border Needed:** 52'
- Rubber Mulch Needed:** 1 Ton
- Wood Mulch Needed:** 2 yds.
- Weed Guard Needed:** 170 sq. ft.
- Total Space Needed:** 12' x 14'

FREESTANDING DOUBLE HAMMOCK SWING



1 CHOOSE YOUR **COLOR**

Green



Blue



Yellow-Red



2 CHOOSE YOUR **TOWER**



4x4 Playdeck
(5' Deck Height)



4x6 Playdeck
(5' Deck Height)



4x8 Double Deck
(5' & 7' Deck Height)



4x8 Split Level Deck
(4' & 5' Deck Height)



6x8 Double Deck
Playhouse Tower
(5' & 7' Deck Height)



6x6 Playdeck
(5' Deck Height)



6x8 Double Deck
(5' & 7' Deck Height)



Triple Cascade Tower
(5', 7' & 9' Deck Height)



6x8 Playdeck
(5' Deck Height)



6x6 Playhouse
(5' Deck Height)



5x6 Climber Tower
(5' Deck Height)

4

CHOOSE YOUR SWING BEAM



3 Position High Beam
(Approx. 10 ft. High)



3 Position Standard Beam
(Approx. 8 ft. High)

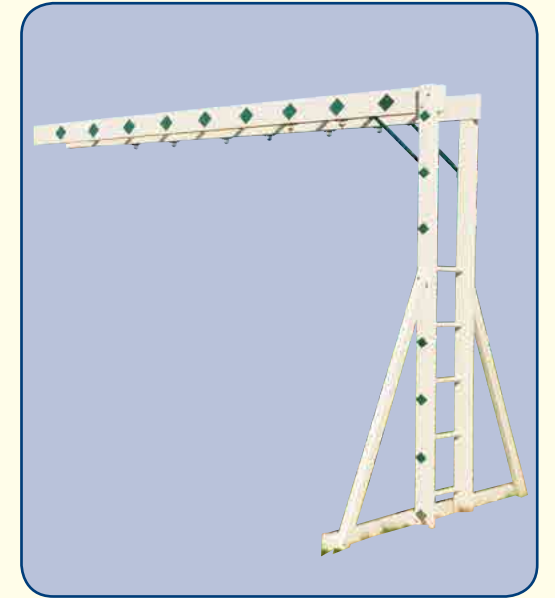

3 Position Monkey Bar
(Approx. 8 ft. High)

3

ADD A TOWER WITH A CONNECTOR

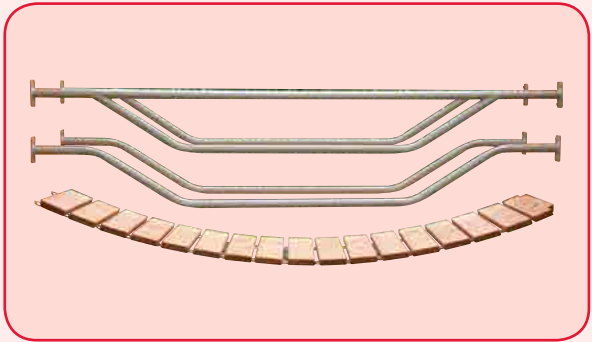

Wobbly Bridge

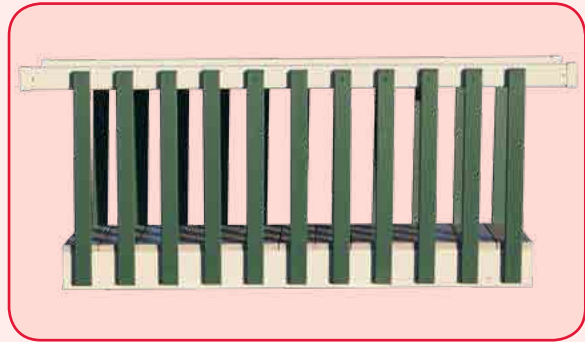

Solid Bridge



Tunnel

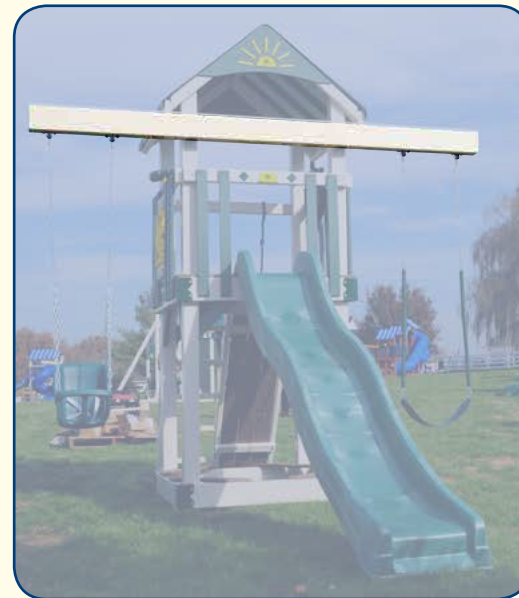

2 Position Beam
(Approx. 8 ft. High)

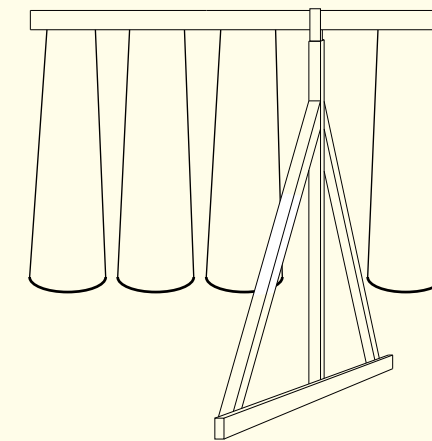

4 Position Standard or High Beam
(8 or 10 ft. High)

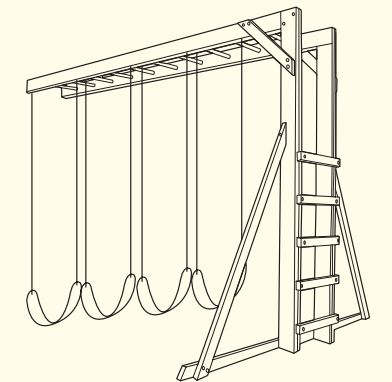

4 Position Monkey Bar
(Approx. 8 ft. High)

5

CHOOSE YOUR SLIDE



10 ft. Waterfall Slide
(5 ft. Deck Height)

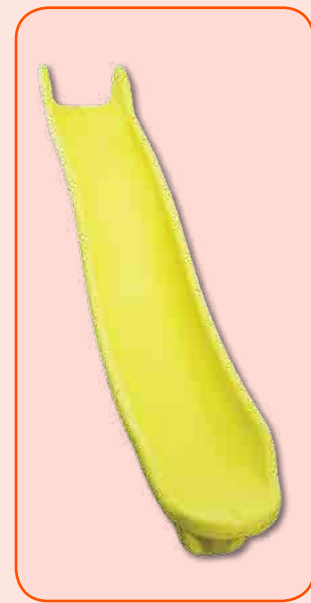

10 ft. Avalanche Slide
(5 ft. Deck Height)

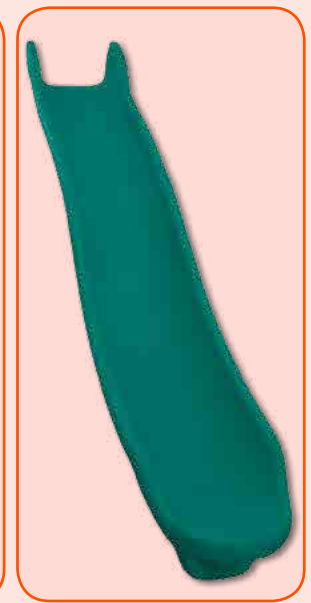

14 ft. Avalanche Slide
(7 ft. Deck Height)



7 ft. Turbo Tube Slide
(7 ft. Deck Height)



5 ft. Tube Tube Slide
(5 ft. Deck Height)
**Blue & Green Only*

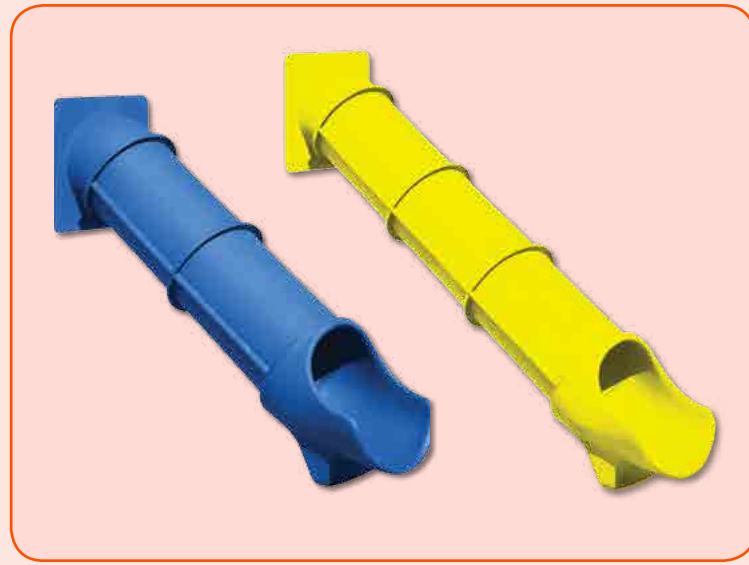

10 ft. Tunnel Express Slide
(5 ft. Deck Height)

14 ft. Tunnel Express Slide
(7 ft. Deck Height)

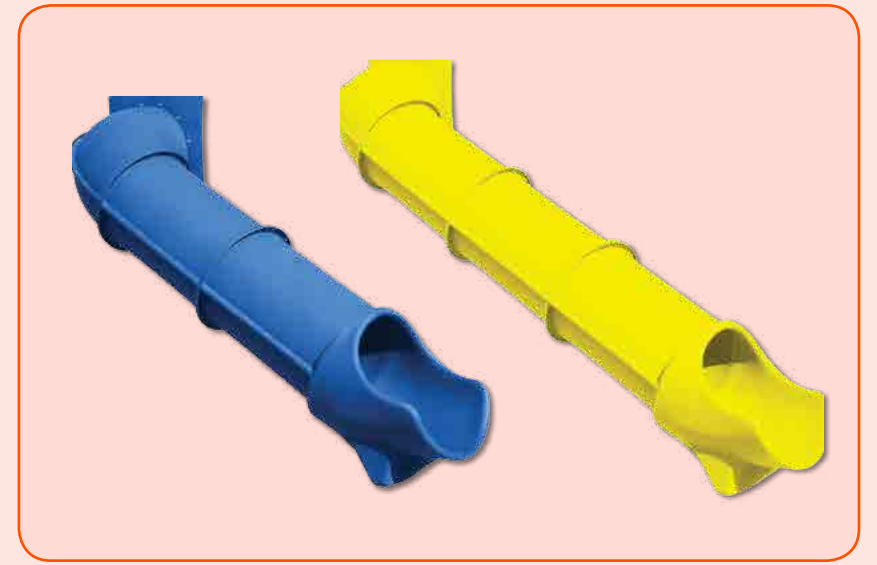

10 ft. Sidewinder Slide
(5 ft. Deck Height)

14 ft. Sidewinder Slide
(7 ft. Deck Height)



5 ft. Super Spiral Slide
(5 ft. Deck Height)



7 ft. Super Spiral Slide
(7 ft. Deck Height)

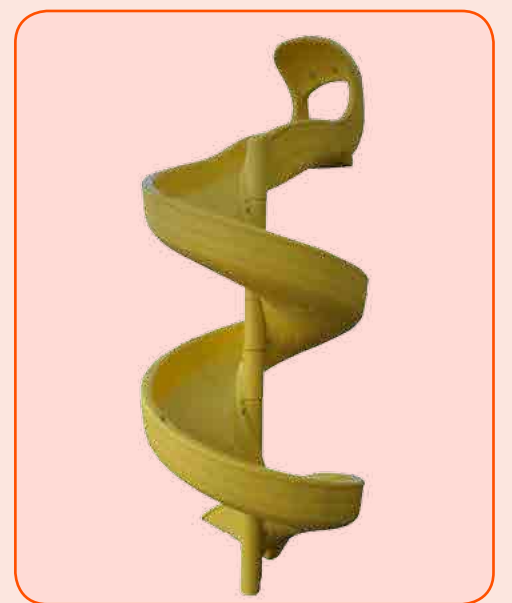

9 ft. Super Spiral Slide
(9 ft. Deck Height)



18 ft. Ball Pit Blast

Blue Yellow Green Slides are available in Blue, Green or Yellow

Did You Know?

Our slides and plastic accessories are made from a heat resistant plastic. This feature gives parents the peace of mind that their children can enjoy our products even on the hottest days of summer!



6 CHOOSE YOUR CLIMBER



5 ft. Climbing Wall/Ladder Combo



5, or 7 ft. Full Width Climbing Wall

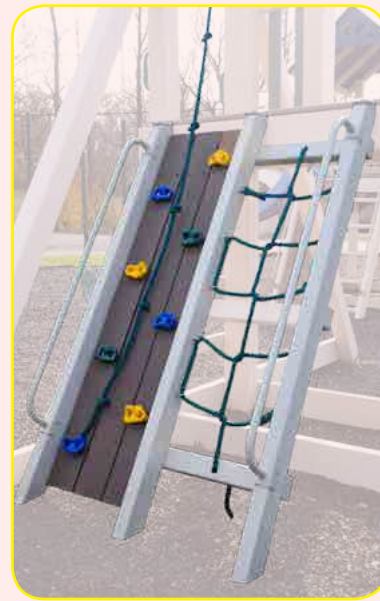

5, or 7 ft. Climbing Wall/Cargo Net Combo



5 ft. Ladder



7 ft. Climbing Wall/Ladder Combo



Staircase



Ramp

7 CHOOSE YOUR ROOFTOP



Fabric

- Red
- Blue
- Green



Asphalt (only available on playhouse)

- Blue
- Cedar
- Green
- Red
- Black
- Light Gray
- Weather Wood



Plastic

- Red
- Blue
- Green

8 CHOOSE YOUR RIDE



Belt Swing

- Blue
- Yellow
- Green

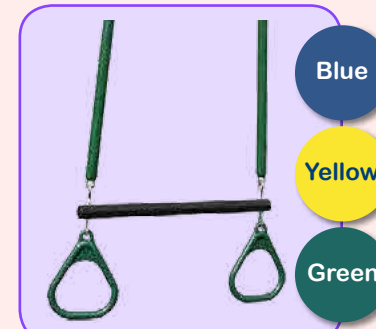

Trapeze/Rings

- Blue
- Yellow
- Green

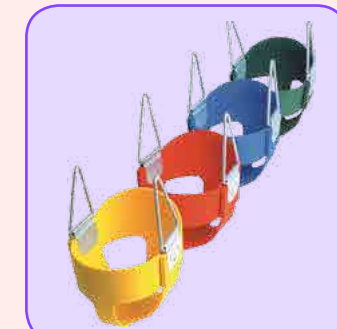

Infant Swing



Deluxe Baby Swing

- Blue
- Yellow
- Green



Green

Buoy Ball



Green

Buoy Ball/Trapeze Combo



Black

2 Rope Tire Swing



Black

3 Rope Tire Swing



Blue

Yellow

Green

Plastic Glider



Blue

Yellow

Green

Together Swing



Hammock Swing



Black

4 Rope Tire Swing

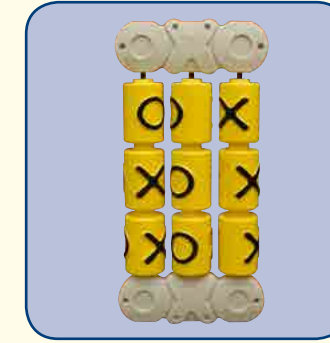

Tic-Tac-Toe



Green

Yellow

Blue

Yellow

Periscope

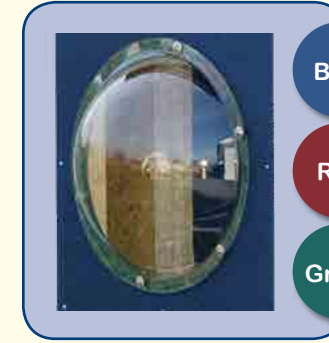

Blue

Red

Green

Bubble Panel



4 or 6 ft. Picnic Table



Blue

Green

Tea Table and Chairs



2x4, 4x4, 4x8, 6x6 Sandbox Covers

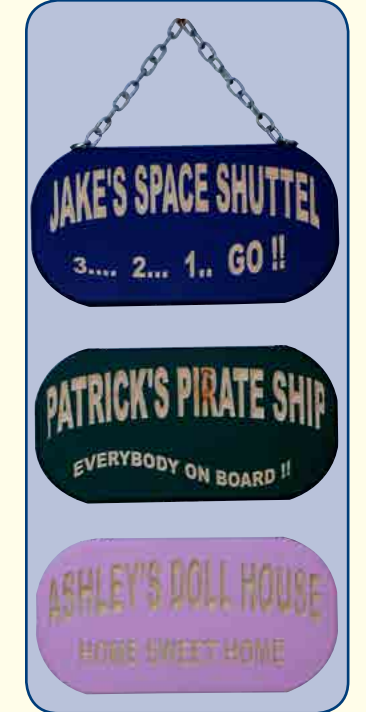

Personalized Engraved Wooden Name Plaques Available for ALL MODELS

9 CHOOSE YOUR Fun Accessories



Firemans Pole

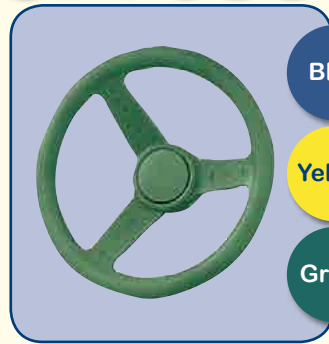

Blue

Yellow

Green

Steering Wheel

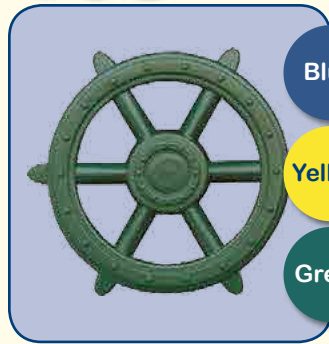

Blue

Yellow

Green

Ships Wheel

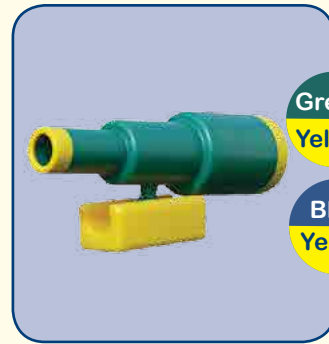

Green

Yellow

Blue

Yellow

Telescope

BALL PIT

Let your kids dive-in and bury themselves in these clean and safe lightweight balls. The wiggles and giggles are sure to follow!

INCLUDES 1500 BALLS!



Mulch, Edging & Weed Guard



**ROUNDED
Plastic Edging**

**WOOD MULCH &
Wood Edging**

10 SURFACING OPTIONS

1. Rubber Mulch:

- Exceptional shock absorbancy
- Reduced risk of playground injuries
- Minimal Maintenance
- Dries quickly after rain
- Will not decompose
- Will not fade
- Non-Staining
- Non-toxic
- Does not freeze
- 99.9% Steel Free



Rubber Mulch Colors



2. Wood Mulch & Borders:

For a traditional play area, we also offer wood mulch accented with wood edging for a clean and classy look.

3. Plastic & Wood Borders:

Keep your play area neat and tidy with our plastic & wood interlocking borders, which come in 4' sections.

4. Weed Guard:

Keep the weeds where they belong, outside of your play area, with our landscaping screen. Our screen comes in wide rolls and can be cut to the desired length for your playset.



Thank You!

For Choosing King Swings

Enjoy!

imagine . climb . play

